

Electrostatic Discharged Protection Devices (ESD) Data Sheet

Description

Brightking's SDD32C36L01-LV is designed to protect voltage sensitive components from ESD and transient voltage events. Excellent clamping capability, low leakage, and fast response time, make these parts ideal for ESD protection on designs where board space is at a premium. Because of its small size, it is suited for use in cellular phones, portable devices, digital cameras, power supplies and many other portable applications. This series are designed to protect sensitive semiconductor components from damage or upset due to electrostatic discharge (ESD), electrical fast transients (EFT), and cable discharge events (CDE).



Contact : ±25kV
Air : ±30kV



- IEC61000-4-2 ESD 30KV Air, 25KV contact compliance
- SOD-323 surface mount package
- Protects bi-directional line
- Peak power dissipation of 320W under 8/20µs waveform
- Working voltage: 36V
- Low leakage current
- Low clamping voltage
- Solid-state silicon avalanche technology
- Lead Free/RoHS compliant
- Solder reflow temperature: Pure Tin-Sn, 260~270°C
- Flammability rating UL 94V-0
- Meets MSL level 1, per J-STD-020
- Marking: 36C

Applications

- Cellular handsets & Accessories
- Cordless phones
- Personal digital assistants (PDAs)
- Notebooks & Handhelds
- Portable instrumentation
- Digital cameras
- Peripherals

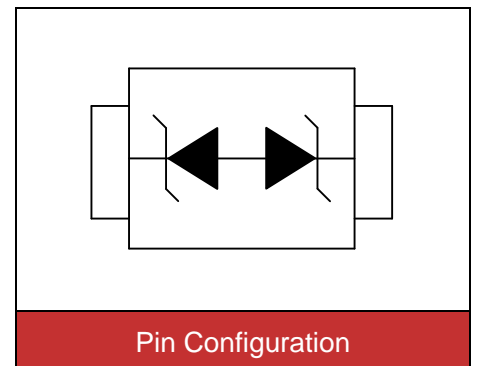

Maximum Ratings

Rating	Symbol	Value	Unit
Peak pulse power (tp=8/20µs waveform)	P _{PP}	320	W
ESD voltage (Contact discharge)	V _{ESD}	±25	kV
ESD voltage (Air discharge)		±30	
Storage & operating temperature range	T _{STG} , T _J	-55~+150	°C

Electrical Characteristics ($T_J=25^{\circ}\text{C}$)

Parameter	Symbol	Condition	Min.	Typ.	Max.	Unit
Reverse stand-off voltage	V_{RWM}				36	V
Reverse breakdown voltage	V_{BR}	$I_{BR}=1\text{mA}$	40			V
Reverse leakage current	I_R	$V_R=36\text{V}$			1	μA
Clamping voltage ($t_p=8/20\mu\text{s}$)	V_C	$I_{PP}=1\text{A}$			58	V
Clamping voltage ($t_p=8/20\mu\text{s}$)	V_C	$I_{PP}=3\text{A}$			60	V
Off state junction capacitance	C_J	$0\text{Vdc}, f=1\text{MHz}$		70		pF

Typical Characteristics Curves

Figure 1. Power Derating Curve

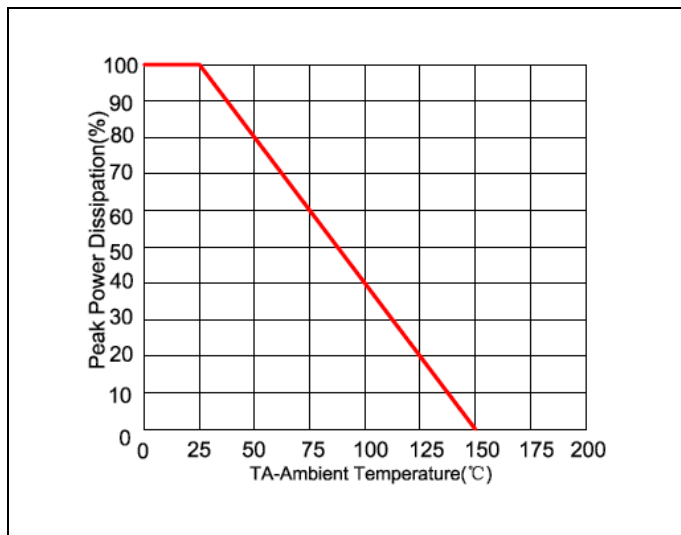

Figure 2. Pulse Waveform

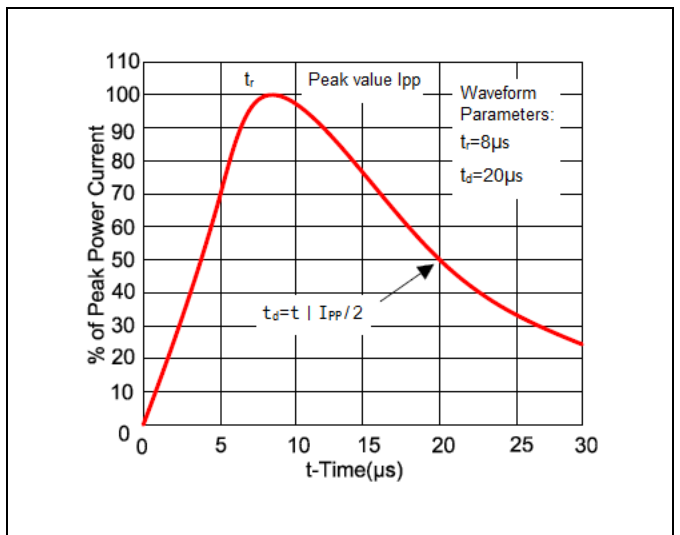

Figure 3. Capacitance vs. Reverse Voltage

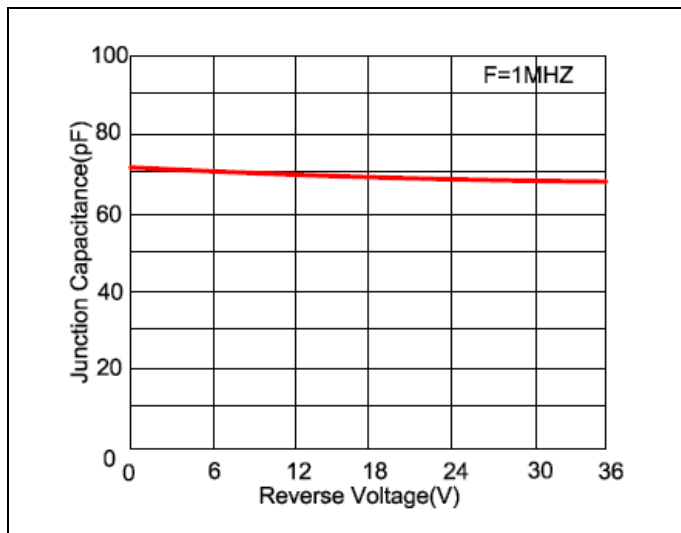
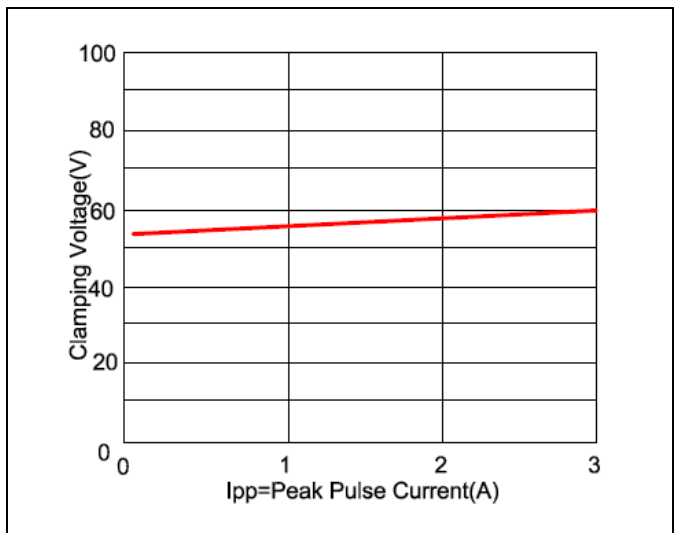
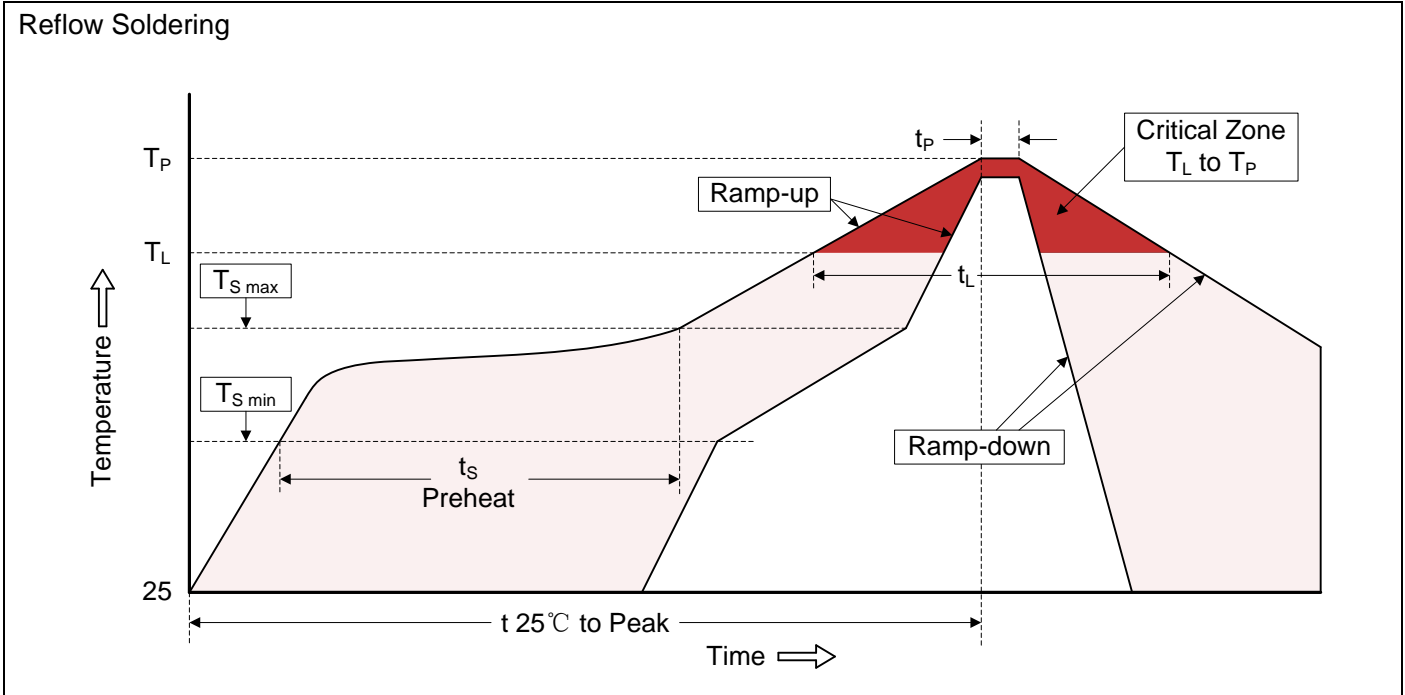

Figure 4. Clamping Voltage vs. Peak Pulse Current



Recommended Soldering Conditions



Recommended Condition

Profile Feature	Pb-Free Assembly
Average ramp-up rate (T_L to T_P)	3°C/second max.
Preheat	
-Temperature Min ($T_{S\ min}$)	150°C
-Temperature Max ($T_{S\ max}$)	200°C
-Time (min to max) (t_s)	60-180 seconds
$T_{S\ max}$ to T_L	
-Ramp-up Rate	3°C/second max.
Time maintained above:	
-Temperature (T_L)	217°C
-Time (t_L)	60-150 seconds
Peak Temperature (T_P)	260°C
Time within 5°C of actual Peak Temperature (t_P)	20-40 seconds
Ramp-down Rate	6°C/second max.
Time 25°C to Peak Temperature	8 minutes max.

Dimensions (SOD-323)

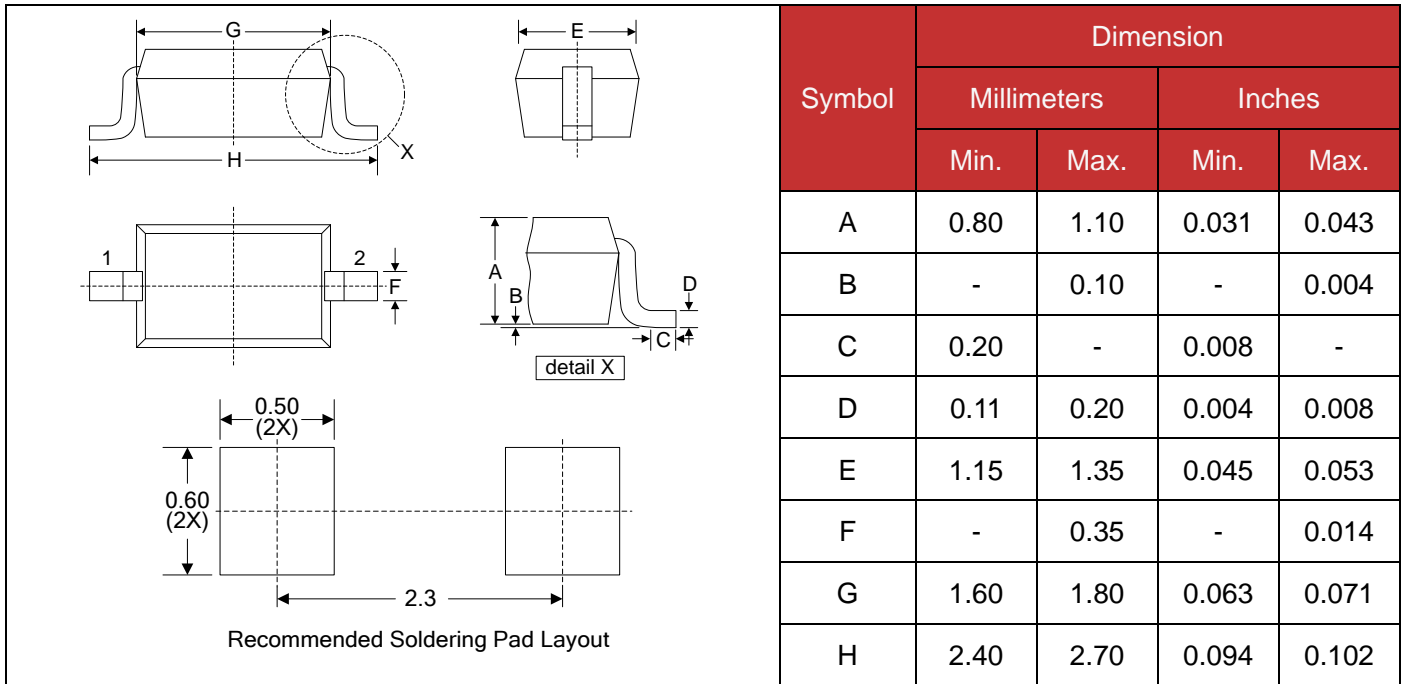

Packaging

