

Thyristor Surge Suppressors (TSS) Data Sheet

Description

DO-214AA Thyristor solid state protection thyristor protect telecommunications equipment such as modems, line cards, fax machines, and other CPE.

P Series devices are used to enable equipment to meet various regulatory requirements including GR 1089, ITU K.20, K.21 and K.45, IEC 60950, UL 60950, and TIA-968 (formerly known as FCC Part 68).



Features

Compared to surge suppression using other technologies, P Series devices offer absolute surge protection regardless of the surge current available and the rate of applied voltage (dv/dt). P Series devices:

- Cannot be damaged by voltage
- Eliminate hysteresis and heat dissipation typically found with clamping devices
- Eliminate voltage overshoot caused by fast-rising transients
- Are non-degenerative
- Will not fatigue
- Have low capacitance, making them ideal for high-speed transmission equipment
- Meets MSL level 1, per J-STD-020

Electrical Parameters

Parameter	Definition
V_{DRM}	Peak Off-state Voltage – maximum voltage that can be applied while maintaining off state
V_S	Switching Voltage – maximum voltage prior to switching to on state
V_T	On-state Voltage – maximum voltage measured at rated on-state current
I_{DRM}	Leakage Current – maximum peak off-state current measured at V_{DRM}
I_S	Switching Current – maximum current required to switch to on state
I_T	On-state Current – maximum rated continuous on-state current
I_H	Holding Current – typical current required to maintain on state
C_O	Off-state Capacitance – typical capacitance measured in off state
I_{PP}	Peak Pulse Current – maximum rated peak impulse current

Electrical Characteristics

Part Number	V _{DRM} (V)	V _S (V)	V _T (V)	I _{DRM} (μA)	I _S (mA)	I _T (A)	I _H (mA)	C _O (pF)	I _{PP} 10/1000μs (A)	V _{PP} 10/700μs (V)	Marking Code
P2300SD	190	260	4	5	800	2.2	50	100	200	8000	P23D

Notes:

- All measurements are made at an ambient temperature of 25°C. I_{PP} applies to -40°C through +85°C temperature range.
- Off-state capacitance(C_O) is measured at 1 MHz with a 2V bias and is typical value.

Thermal Considerations

Package DO-214AA/SMB	Symbol	Parameter	Value	Unit
	T _J	Operating Junction Temperature	-40 to +125	°C
	T _S	Storage Temperature Range	-40 to +150	°C
	R _{θJA}	Junction to Ambient on printed circuit	90	°C/W

Part Number Code and Marking

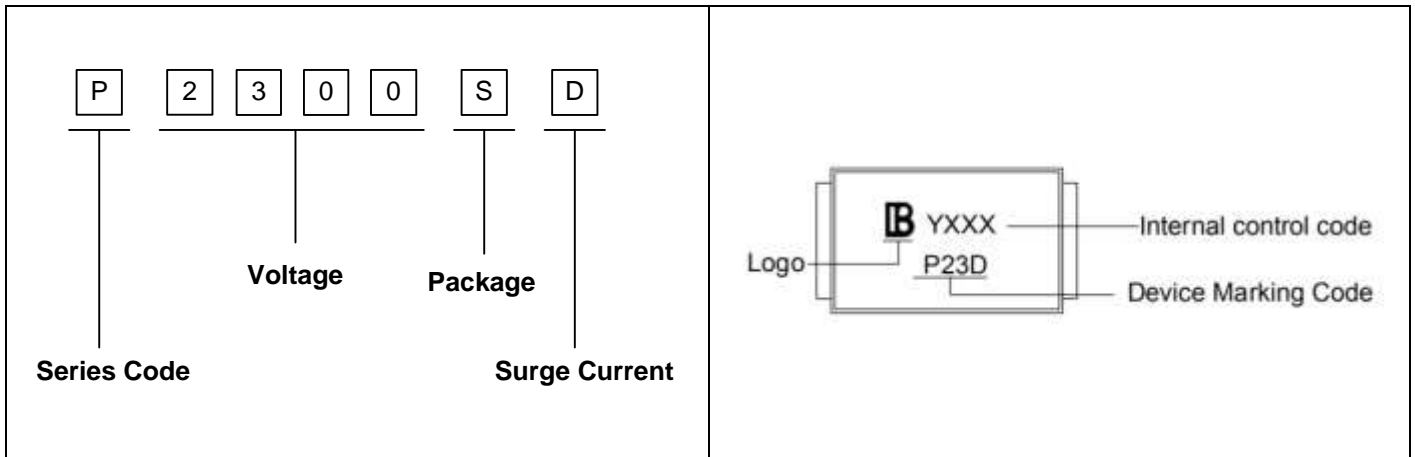

Characteristics Curves

Figure 1. V-I Characteristics

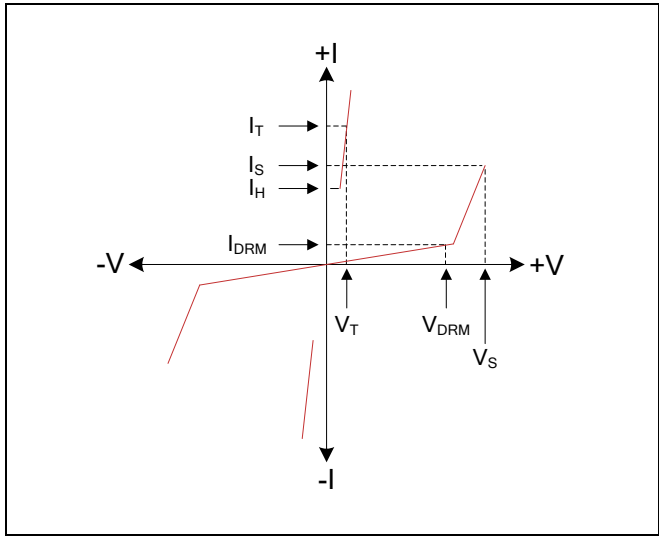

Figure 2. $t_r \times t_d$ Pulse Wave-form

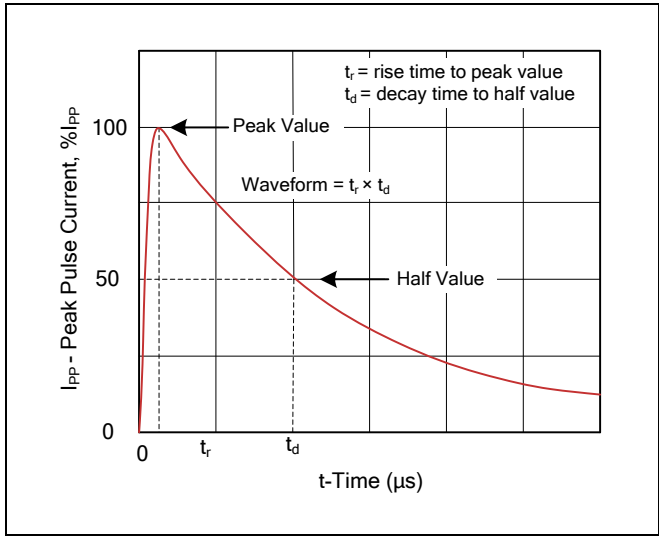

Figure 3. Normalized V_S Change versus Junction Temperature

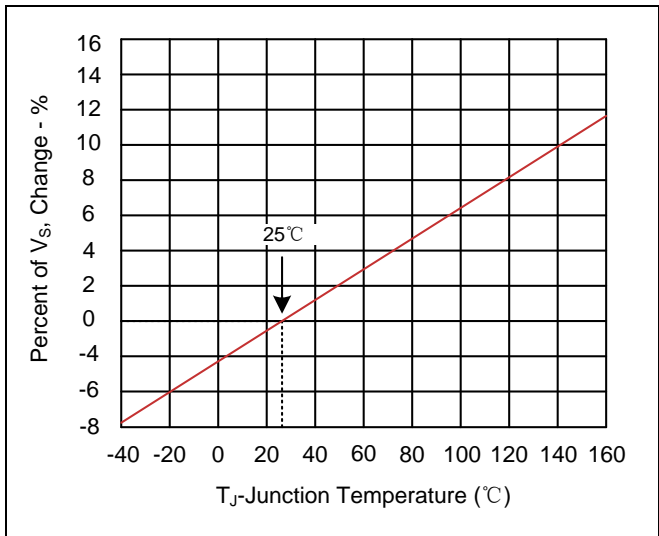
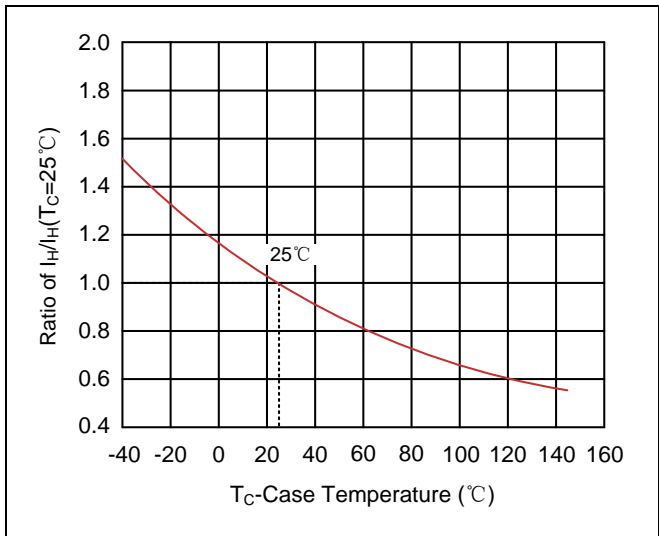
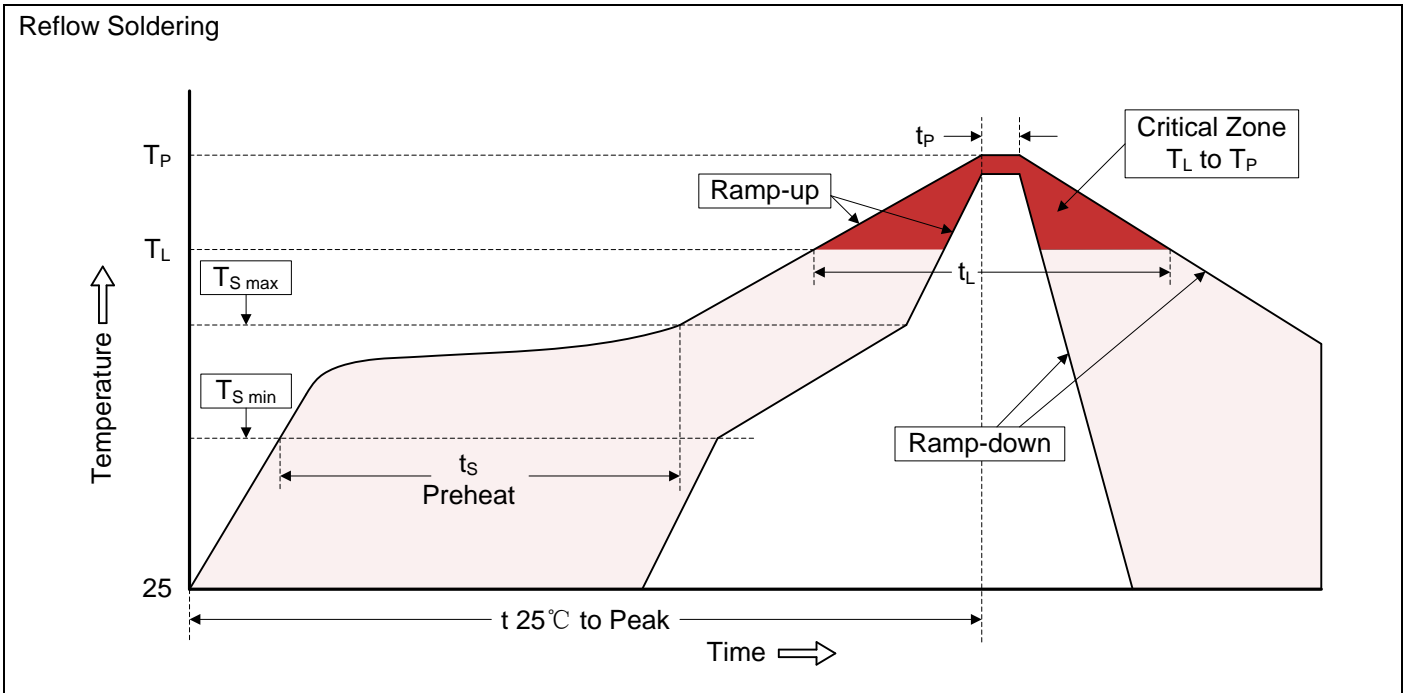

Figure 4. Normalized DC Holding Current versus Case Temperature



Recommended Soldering Conditions



Recommended Conditions

Profile Feature	Pb-Free Assembly
Average ramp-up rate (T_L to T_P)	3°C/second max.
Preheat <ul style="list-style-type: none"> -Temperature Min ($T_{S\ min}$) -Temperature Max ($T_{S\ max}$) -Time (min to max) (t_s) 	150°C 200°C 60-180 seconds
$T_{S\ max}$ to T_L <ul style="list-style-type: none"> -Ramp-up Rate 	3°C/second max.
Time maintained above: <ul style="list-style-type: none"> -Temperature (T_L) -Time (t_L) 	217°C 60-150 seconds
Peak Temperature (T_P)	260°C
Time within 5°C of actual Peak Temperature (t_P)	20-40 seconds
Ramp-down Rate	6°C/second max.
Time 25°C to Peak Temperature	8 minutes max.

Dimensions (SMB/DO-214AA)

Symbol	Millimeters		Inches	
	Min.	Max.	Min.	Max.
L	4.06	4.70	0.160	0.185
D	3.30	3.94	0.130	0.155
D1	1.90	2.20	0.075	0.086
T	5.21	5.59	0.205	0.220
T1	0.76	1.52	0.030	0.060
d	-	0.203	-	0.008
H	1.95	2.65	0.077	0.104

Packaging

Tape		Symbol	Dimension (mm)
		W	12.00±0.30
		P0	4.00±0.10
		P1	8.00±0.10
		P2	2.00±0.10
		D0	Φ1.55±0.05
		D1	Φ1.55±0.05
		E	1.75±0.10
		F	5.50±0.10
		A0	3.76±0.10
		B0	5.69±0.10
<p>13" Reel</p>		K0	2.70±0.10
		T	0.25±0.10
		D2	Φ330.0±2.0
		D3	Φ13.5±0.5
		H	2.5±0.5
W1	16.0±1.0		
		Quantity: 3000PCS	